Thanks for choosing LEDempire Standard LED Explosion Proof Light Series.
These instructions should be read fully and carefully before attempting to install the light.



Produce by NIBBE®

Explosion-proof LED Light :

Model EPL03

Instructions for Use

ATEX Standard



Baltic states representative: **"S.E.P.,Ltd" SIA**

Address: Pulkveza Brieza str. 35, Riga, LV-1045, Latvia

Tell: +371-66077400, +371-66077401

Web: www.ledempire.lv

Email: sales@ledempire.lv

Note: Save these instructions for future reference.

This light is designed for illumination of hazardous locations. It uses the latest in solid state lighting technology for long life, low maintenance, and high efficiency.

The unique optical design focuses light downward to where it is needed, giving improved efficiency over a conventional HID luminaries.

A special designed supply allows it to be used from any nominal 120V-227V, 50/60Hz AC supply without any variation in light output.

This lamp is suitable for use in the following locations: II 2 G Ex d IIB T6 Gb, III 2 D Ex t IIIC T95°C Db

⚠ WARNING

To avoid the risk of fire, explosion, or electric shock, this product should be installed, inspected, and maintained by a qualified electrician only, in accordance with all applicable electrical codes

⚠ WARNING

To avoid electric shock:

- Be certain electrical power is OFF before and during installation and maintenance.
- Luminaries must be connected to a wiring system with an equipment-grounding conductor

⚠ WARNING

To avoid explosion:

- Make sure the supply voltage is the same as the rated luminaire voltage.
- Do not install where the marked operating environments exceed the ignition temperature of the hazardous atmosphere.
- Do not operate in ambient environments above those indicated on the luminaire nameplate.
- Use proper supply wiring as specified on the luminaire nameplate.
- Keep covers tightly closed when in operation. No user serviceable parts inside.

⚠ WARNING

For supply connections use wire rated for at least 90°C

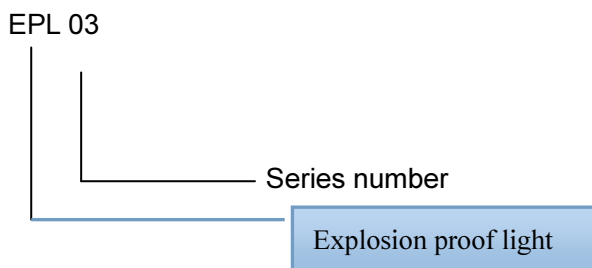
1. Definition of model number**2. Characteristics**

(1) High efficient LED module is adopted as light source and most advanced electrical technology is applied. This enables low power consumption, efficient light-emitting and instant lighting at the

same time.

(2) The light has unique structure; simple and compact but ideal for heat diffusion (patented), tight enough for sealing (waterproof and dust prevention of IP66) and tough against shocks and corrosions. This assures long service life of the light.

(3) By unique optical design, light irradiation range is wide and illumination intensity is high.

(4) There are various mounting options and mounting is very easy.

3. Specifications

No.	Items	Unit	Specifications
1	Nominal AC Supply Voltage	V	120-227VAC
2	Rated frequency	Hz	50/60Hz
3	LED Power consumption	W	80W
4	Life time	Hrs	≥ 50000
5	Efficiency of light	%	90
6	Protection Code		IP66
7	Ex. mark		II 2 G Ex d IIB T6 Gb, III 2 D Ex t IIIC T95°C Db
8	External dimensions	mm	300 x 300 x 250mm (with bracket)
9	Net Weight	kg	6.5

4. Attentions

(1) Before mounting and use of the light, read through this Instructions and check whether voltage of power source conforms to that required for the light. If not, it may cause breakdown of the light and there may be a case that you should choose a differently rated light.

(2) Make surface of the light case and lens clean to ensure light transmittance and heat diffusion.

(3) Be careful not to have the light case contacted to hard materials in order to avoid scratches.

(4) Do not let amateur mount the light, professional personnel.

(5) Never neglect to ground the light. It is important to ensure security of power source and protection from lightening surge of the light.

(6) Ambient temperature for the light should be in the range from -50°C to 35°C. Make forceful ventilation to accelerate heat diffusion when necessary.

(7) Repairs and maintenance

- i) Check periodically elasticity of sealing materials. In case they lose elasticity due to aging, replace them with those of exactly same specifications (both size and hardness). Alternative materials may not be used.
- ii) Conduct periodically insulation resistance test with 500V Megger so that insulation resistance does not get lower than 2MΩ.
- iii) In maintenance work, take care of the surface of flameproof enclosures. As the surface may not have damages and corrosion, it was coated with rust-proof oil 204-1 in assembly. Do not soil the surface or damage the sealed part.

5 Cautions

IN ALL REPAIRS, MAINTENANCE AND OTHER WORKS, IT IS REQUIRED TO CUT OFF POWER BEFORE THE WORKS. DO NOT OPEN THE LAMP WHEN IT IS ENERGIZED. DURING THE INSTALLATION, PLS KEEP IN MIND YOU ARE WORKING AT HAZARDOUS

PLACE. MAKE SURE YOU ARE FOLLOWING THE LAW AND RULES.**6 Mounting**

Pendant, Ceiling, Wall or Bulkhead Mount or Stanchion Mount, Street light

- (1) Decide a place to mount the light and make sure the cable to connect the lamp is WITHOUT ELECTRICITY.
- (2) Choose a mounting type. Mounting types are illustrated below.

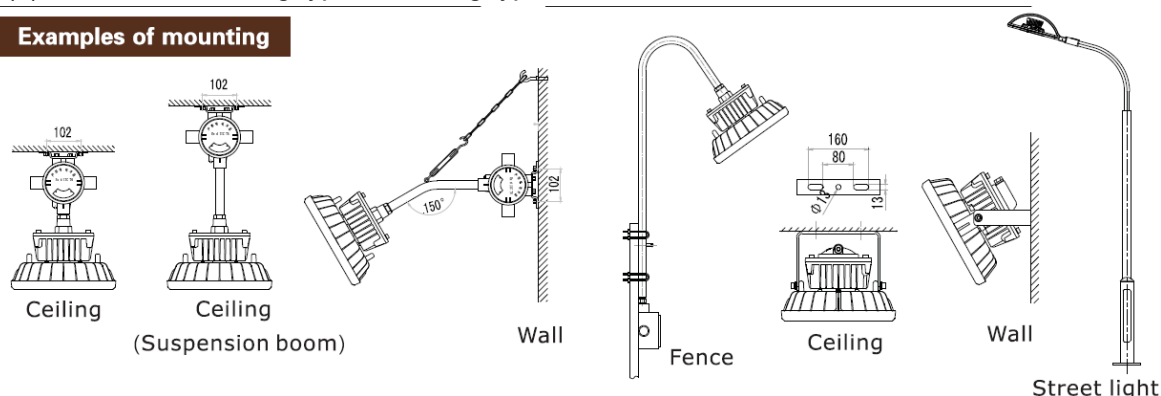
Examples of mounting**7 HOW TO CONNECT THE POWER WIRE WITH THE LAMP**

(THE FOLLOWING PHOTO IS FOR DEMONSTRATION, THE REAL PRODUCT MAYBE NOT THE SAME)

- 1) Use M8 inner hex wrench to turn off the 4 screws by turning counter-clock-wisely
- 2) Remove the Power Supply Cover to attach incoming power to the fixture. You will find two terminals, one terminal has both sides connected, it is the one connects the LED lighting source and the output side of the driver. Another terminal has one side connected and other side unoccupied. That is the terminal connects the input side of the driver and outside supply wire. **THIS IS THE TERMINAL WE ARE LOOKING FOR. THE INPUT TERMINAL SHOULD HAVE MARKINGS ON THE LINES, INDICATING LIVE LINE (L), NEUTRAL LINE (N) AND GROUND LINE (E). IF MARKINGS ARE NOT INCLUDED, USUALLY THE GROUND LINE IS IN GREEN/YELLOW COLOR. LIVE LINE (L) IS IN WHITE OR RED COLOR, THE NEUTRAL LINE (N) IS IN BLACK OR BLUE COLOR. IF YOU ARE NOT SURE, CONTACT US.**
- 3) Connect triple core power cable of the light with cable from AC power source. **THE TRIPLE CORE LINE HAS MARKINGS ON THE LINES, INDICATING LIVE LINE (L), NEUTRAL LINE (N) AND GROUND LINE (E). IF THE COLOR OF THE POWER WIRE IS RED, BLACK AND GREEN/YELLOW, USUALLY RED IS FOR LIVE, BLACK IS FOR NEUTRAL AND GREEN/YELLOW IS FOR GROUND. GREEN/YELLOW WIRE CONNECTS TO SAFETY GROUND. MAKE SURE YOU CONNECT THE GROUND LINE (E) WITH THE GROUND LINE (E), LIVE LINE (L) WITH LIVE LINE (L). OTHERWISE, IT MAY CAUSE TO SHORT CIRCUIT. IF YOU ARE NOT SURE, CONTACT US.**



(This photo is close to the real product, pls reference it mainly when wiring. In the photo, the white and red wires are live lines, the black wires are neutral lines and the green/yellow is ground line) Connect each line rightly with the input terminal of the cable from the AC power source respectively by using screwdriver.

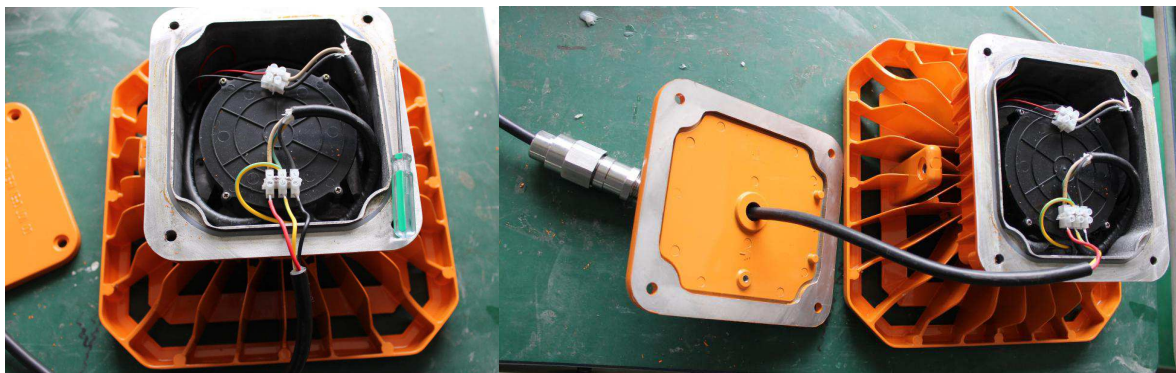

4) Put the driver cover back and tighten the 4 screws.

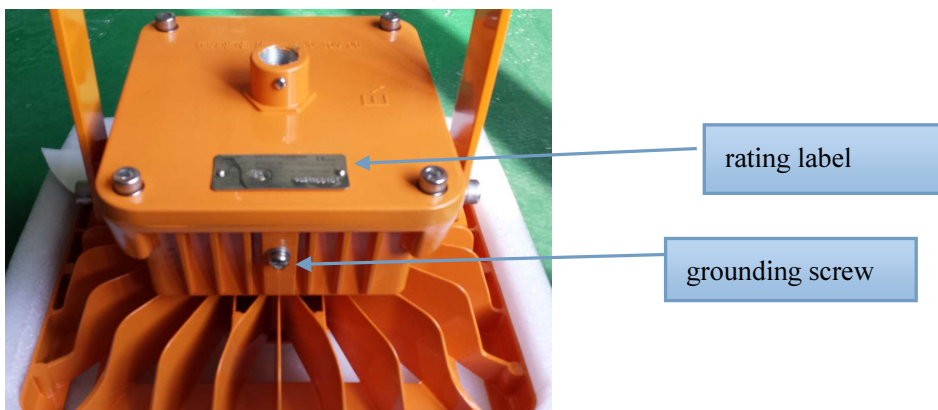

WHEN YOU PUT THE COVER BACK, PAY ATTENTION TO THE MAKE SURE THE SIDE OF BACK COVER WITH THE RATING LABEL IS JUST ABOVE THE GROUNDING SCREW, JUST LIKE THE ATTACHED PHOTO, THIS IS VERY IMPORTANT.

To maintain seal, make sure that the O-ring is still present and properly seated in the groove. Make sure that the screws are tightened completely

5) Connect the three-core power wire with IP66 explosion proof junction box if explosion proof junction box is necessary.

If the lamp is connected with the utility system directly, then no explosion proof junction box is

required. But you need explosion proof switch to control the lamp.

6) Switch on the light. Check whether it works normally.

7) Restore power and verify operation

8) Fix the light by the way you choose.

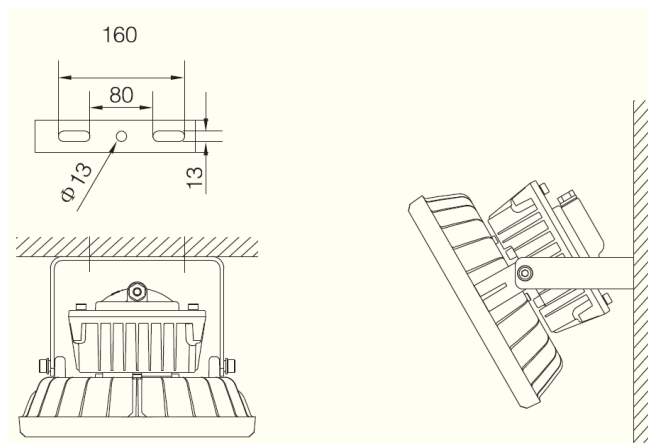

The model has a bracket/frame, the height of the whole lamp (includes the frame/ bracket) is 250mm).

※ If you choose to use bracket/frame, you will note that it has 3 holes, pls check the size of the two side holes on the bracket in the above drawing, which is 40*13mm, the middle hole is $\Phi 13$. You can prepare 3 stainless or anti-corrosion screws which can hold the light even during hurricane. Fix the lamp by 3 strong screws tightly. Pls recheck the screws every few months, it depend on the environment you use. Check your local standard for screw.

※ If you choose to use a pole with tube to connect with the 1/2 NPT gland, check whether

- i the cable is long enough
- ii the pole and the gland are fix well

If you choose to fix the light by fence, pls make sure the fence or pole is strong enough to against hurricane and corrosion.

DIMENSIONS ARE FOR REFERENCE ONLY

8. Maintenance

To avoid personal injury, disconnect power to the light and allow the unit to cool down before performing maintenance.

⚠ Warning: No user serviceable parts inside of power supply enclosure. Risk of electric shock. Removal of the power supply cover will void the warranty.

1) Perform visual, mechanical and electrical inspections on a regular basis. We recommend routine checks to be made on a yearly basis. Frequency of use and environment should determine this. It is recommended to follow an Electrical Preventive Maintenance Program as described in NFPA 70B: Recommended Practice for Electrical Equipment.

2) The lens should be cleaned periodically as needed to ensure continued photometric performance. Clean the lens with a damp, non-abrasive, lint-free cloth. If not sufficient, use mild soap or a liquid cleaner. Do not use an abrasive, strong alkaline or acid cleaner as damage may occur.

3) Inspect the cooling fins on the luminaire to ensure that they are free of any obstructions or contamination (i.e. excessive dust build-up). Clean with a non-abrasive cloth if needed.

4) Do not operate if the lens is cracked or damaged. All fasteners should be properly seated

9. Trouble shooting

Trouble	Cause	Treatment
Light does not shine.	Light source is broken.	Replace the light source.
	Cable is not in good order.	Check the cable.
Light flickers.	Voltage is too low.	Check the voltage.

*In case you cannot solve the problem, contact us.

All statements, technical information and recommendations contained herein are based on information and tests we believe to be reliable. The accuracy or completeness thereof is not guaranteed. Since conditions of use are outside our control, the purchaser should determine the suitability of the product for his intended use and assumes all risk and liability whatsoever in connection therewith.

Note: Save these instructions for future reference. Copies of these instructions should be held in a safe place for future reference. It is the responsibility of the installer to ensure that the apparatus selected is fit for its intended purpose and that the installation, operation and maintenance of the apparatus complies with applicable regulations, standards or codes of practice.